

SPECIFICATION



Contents

1. Description	
1.1 General Description	
1.2 Features	
1.3 Application	
1.4 Package Dimension	
1.5 Product Parameters	
1.6 Typical optical characteristics curves	
2. Packaging	
2.1 Packaging Specification	
2.1.1 Carrier Tape Dimension	11
2.1.2 Reel Dimension	11
2.1.3 Label Form Specification	12
2.2 Moisture Resistant Packing	
2.3 Cardboard Box	
2.4 Reliability Test Items And Conditions	
2.5 Criteria For Judging Damage	
3. SMT Reflow Soldering Instructions SMT	
3.1 SMT Reflow Soldering Instructions SMT	
3.1.1 Soldering Iron	17
3.1.2 Repairing	17
3.1.3 Cleaning	17
4. Handling Precautions	
4.1 Handling Precautions	
4.1.1 Storage	18
4.1.2 Static Electricity	19
4.1.3 Reverse voltage protection	19
4.1.4 The safe temperature for LEDs working	20



4.1.5 Directionsfor Use	20
4.1.6 Others	22
4.1.7 Declare	23



1. Description

1.1 General Description

The product is a full-color LED device, Common cathode RGB SMD, High contrast(Designed on all black surface),The product size: 2.05mmX2.15mmX1.9mm.

LED RGB SMD ()
2.05mmX2.15mmX1.9mm

1.2 Features

Extremely wide viewing angle.

High luminous Intensity, Low power dissipation, Good reliability and Long life.

Water-resistant (IPX6). (IPX6)

Moisture sensitivity level: 5a. :5a

RoHS compliant. RoHS

Matte surface.

Pb-free reflow soldering applic30.71 842.0 5.000.g Tm571 0 595.32 842.04g9E-94 0 0 1 51.24 330.29

1.4 Package Dimension

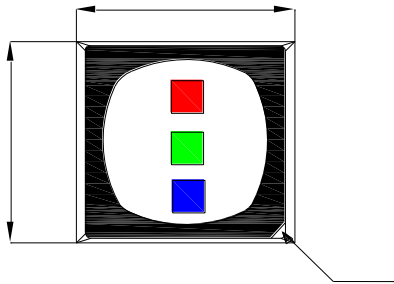

Fig.1-1 Top view

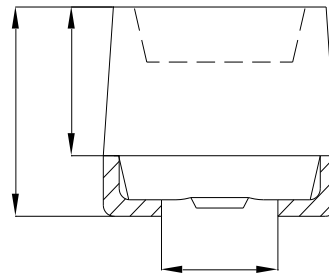

Fig.1-2 Side view

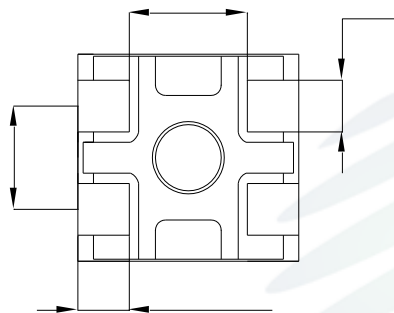

Fig.1-3 Bottom view

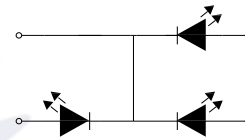

Fig.1-4 Polarity

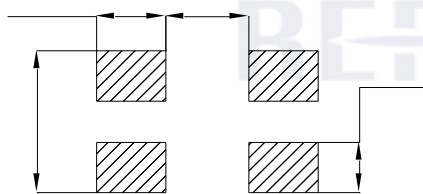

Fig.1-5 Soldering patterns

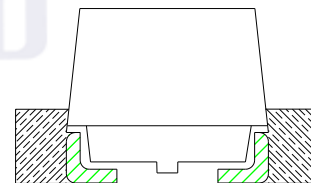
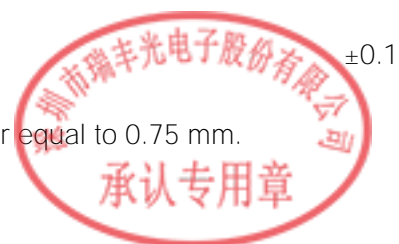

Fig.1-6 Glue filling

Notes

1. All dimensions units are millimeters.
2. All dimensions tolerances are ± 0.1 mm unless otherwise noted.
3. Recommendation for glue filling: filling height must be higher than or equal to 0.75 mm.

0.75 mm



1.5 Product Parameters

Table 1-1 Electrical / Optical Characteristics at Ts=25°C

Item	Symbol	Test Condition	Value			Unit
			R	G	B	
Reverse Current	I_R	$V_R=5V$	6	6	6	
Forward Voltage	V_F (min)	R $I_F = 15mA$ G $I_F = 15mA$ B $I_F = 10mA$	1.7	2.7	2.7	V
	V_F (max)		2.4	3.4	3.4	V
Dominant Wavelength	λ_D		617~ 628	520~540	460~475	nm
			5nm per Bin	3nm per Bin	3nm per Bin	
Spectrum Radiation Bandwidth			24	38	30	nm
Luminous Intensity	$I_{V(min)}$		265	550	68	mcd
	$I_{V(avg)}$		420	880	110	mcd
	$I_{V(max)}$		670	1400	175	mcd
	BIN Range		1:1.3	1:1.3	1:1.3	
Viewing Angle	0 1/2			110		

Table 1-2 Absolute Maximum Ratings at Ts=25°C

Parameter	Symbol	Absolute Maximum Ratings			Unit
		R	G	B	
Forward Current	I_F	20	15	15	mA
Reverse Voltage	V_R	5	5	5	V
Operating Temperature	T_{OPR}	-30 ~ +85			
Storage Temperature	T_{STQ}	-40 ~ +100			
Power Dissipation	P_D	48	51	51	mW
Sns k t m slmmSdl odq st qd	T_J	100	100	100	
Electrostatic Discharge (HBM)	E_{SD}	1000V			

Notes

1. The above forward voltage measurement allowance tolerance is $\pm 0.1V$. $\pm 0.1V$
2. The above Tolerance of measurement of dominant wavelength $\pm 1nm$. $\pm 1nm$
3. The above luminous intensity measurement allowance tolerance $\pm 10\%$. $\pm 10\%$
4. Care is to be taken that power dissipation does not exceed the absolute maximum rating of the product.
5. All measurements were made under the standardized environment of Refond.
6. Luminous intensity range is for reference only,specific parameters please refer to the label.

1.6 Typical optical characteristics curves

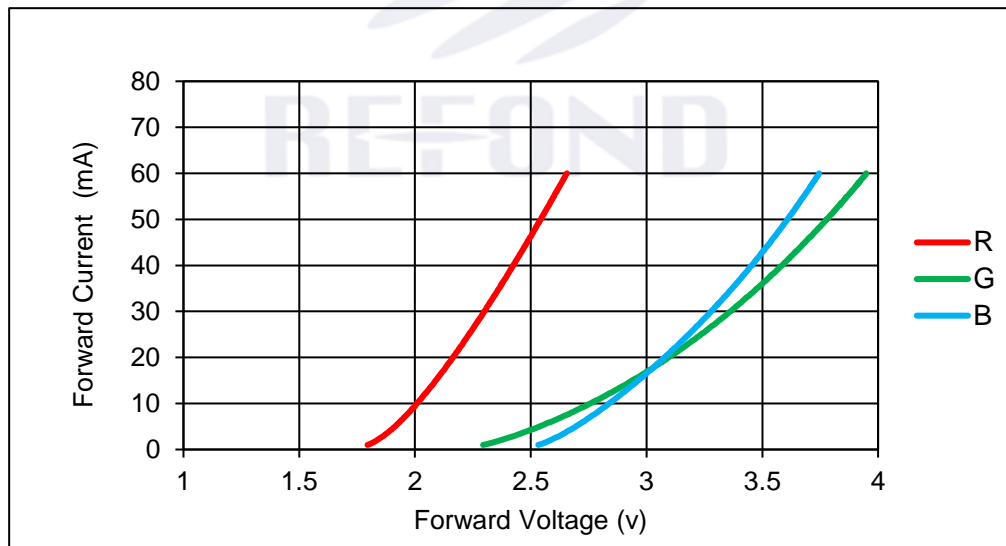

Fig 1-6 Forward Voltage Vs. Forward Current



Fig 1-7



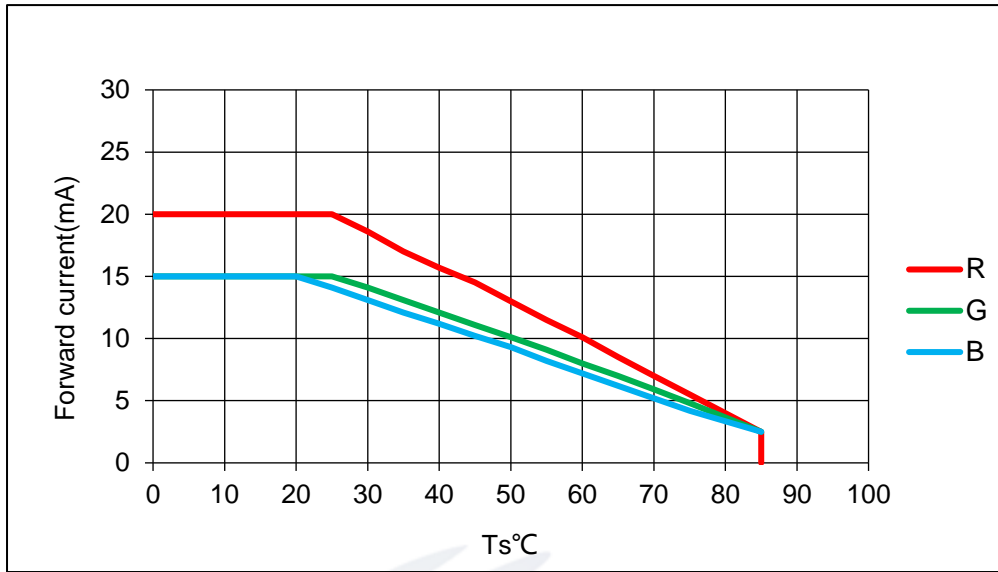

Fig 1-9 Solder Temperature Vs Forward Current

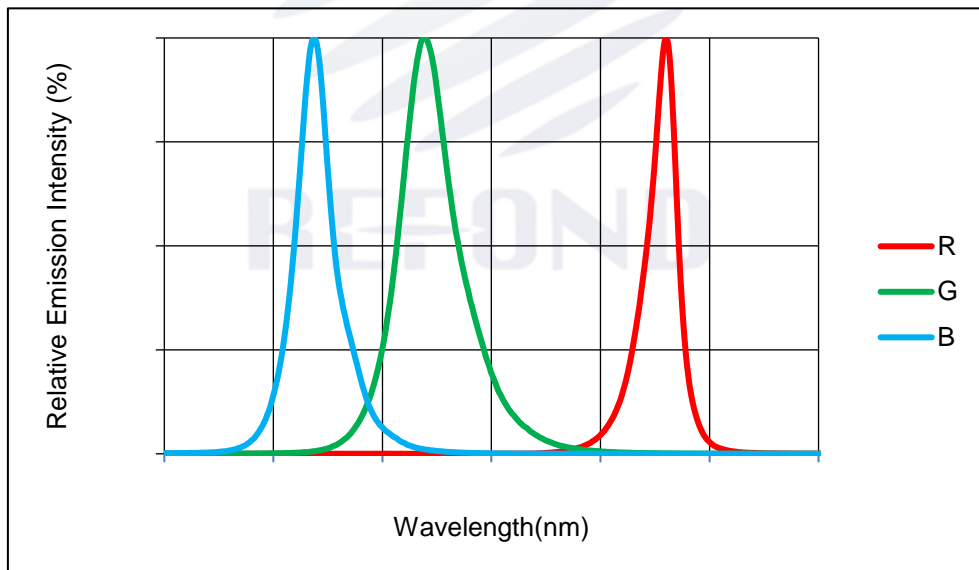

Fig 1-10 Spectrum Distribution



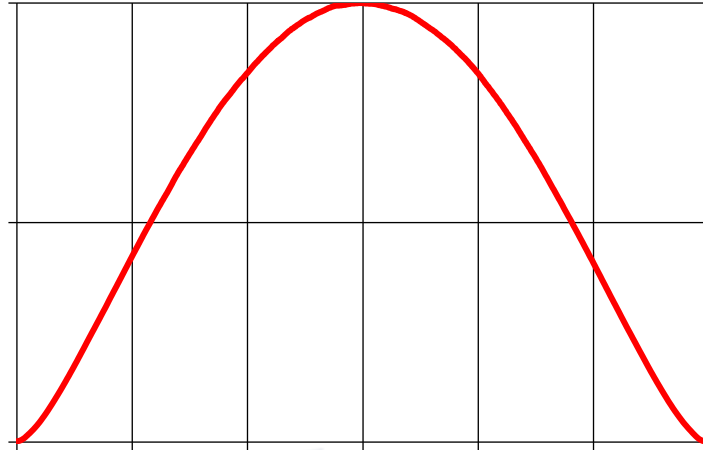

Fig 1-11 Directivity X-X radiation angle X

REFOND

Fig 1-12 Directivity Y-Y radiation angle Y

2. Packaging

2.1 Packaging Specification

Package:13000pcs/reel. 13000pcs

2.1.1 Carrier Tape Dimension

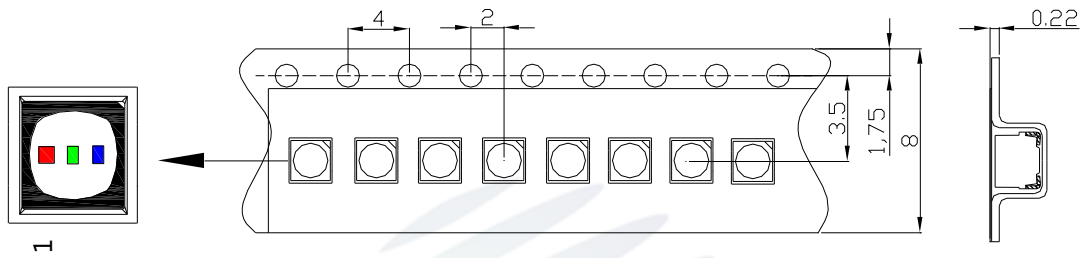

Fig.2-1 Carrier Tape Dimension

2.1.2 Reel Dimension

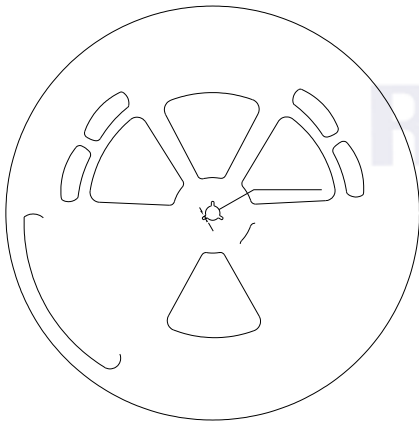

Fig.2-2 Reel

Table 2-1 Dimension

A	400±2mm
B	100.0±0.4mm
C	14.3±0.3mm
D	2.6±0.2mm
E	12.4±0.3mm
F	8.6 0.2/-0.3 mm
T	1.9±0.2mm

Notes

The tolerances unless mentioned ±0.1mm. Unit : mm

±0.1



2.1.3 Label Form Specification

Table 2-2 Description

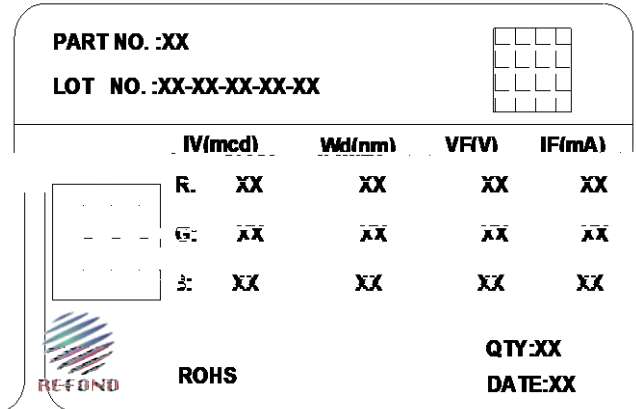

PART NO.	Part Number
LOT NO.	Lot Number + Packing Machine No. + Serial Number +BIN No. + Quantity (K)
	+ + +BIN + K
IV	Light intensity
VF	Forward Voltage
Wd	Wavelength
IF	Forward current
QTY	Packing Quantity
DATE	Made Date

Fig 2-3 Label

2.2 Moisture Resistant Packing

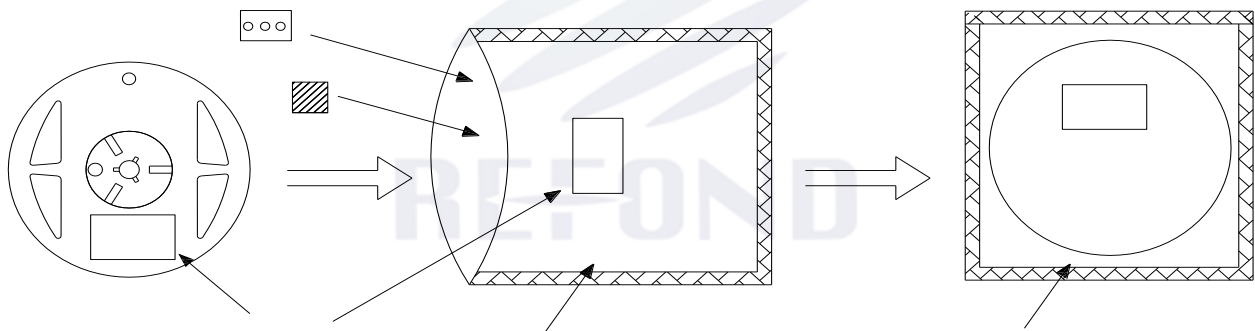

Fig.2-4 Pack



2.3 Cardboard Box

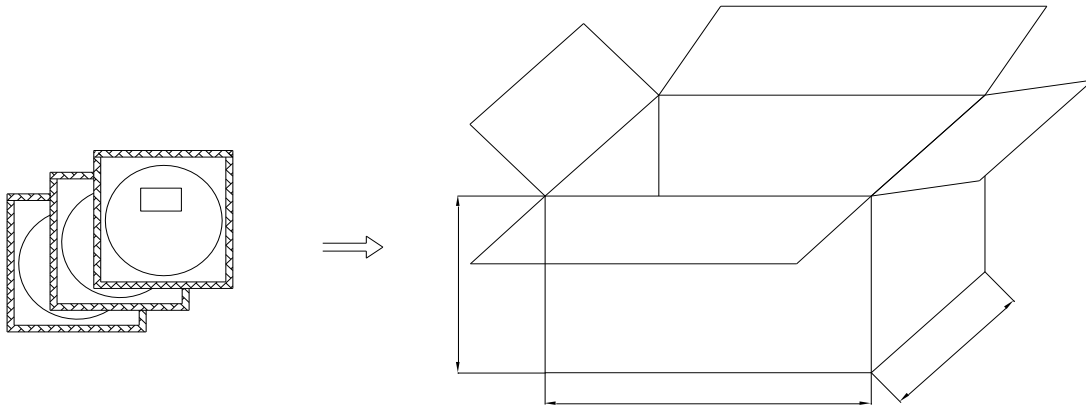
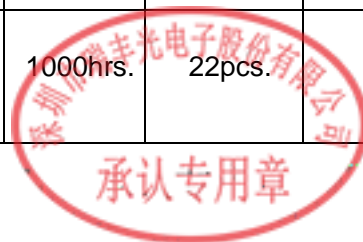

Fig.2-5 Box

2.4 Reliability Test Items And Conditions

Table 2-3 Reliability Condition

Test Items	Ref.Standard	Test Condition	Time	Quantity	Ac/Re /
Resistance to Soldering Heat	JESD22-B106	Temp:250 max T=10 sec	3times	22pcs.	0/1
Thermal Shock	JEITAED-4701 300 307	-40 15min 10s 100 15min	500cycle	22pcs.	0/1
Moisture Resistance	IPC/JEDEC J-STD-020D.1	1. Moisture Absorption Ta=85 / RH=85%/12HR 2. Tsol=250 , T=10s Reflow Soldering	3times	22pcs.	0/1
High Temperature Storage	JEITAED-4701 200 201	Temp:100	1000hrs.	22pcs.	0/1





Notes

1. The Reliability tests are based on Refond existing test platform.
2. The above reliability tests is based on the verification of a single/strip LED of Refond's existing experimental platform, the reliability experiment was taken under good heat dissipation conditions. when customers applies the LED to the series and parallel circuit, should take consideration of all the factors such as the current, voltage distribution, heat dissipation and others.

LED

/ LED

3. SMT Reflow Soldering Instructions SMT

3.1 SMT Reflow Soldering Instructions SMT

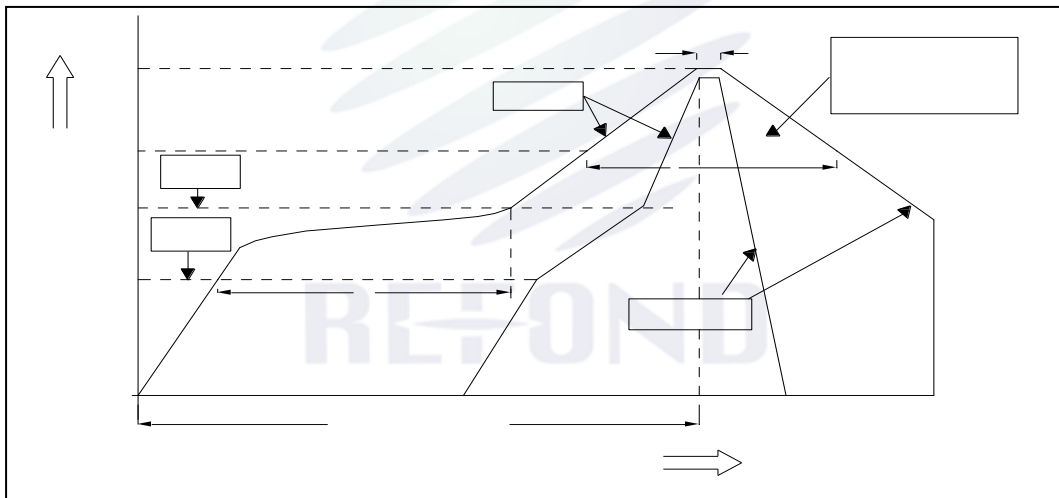

Fig.3-1 Profile



caused by heat or atmosphere.

6. This product can differ in optical characteristics depending on the number of reflow cycles. In a single display, only LEDs with same number of reflow cycles should be used regardless of the application type, such as rental and/or permanent installations.

LED.

7. This LED is designed to be reflow soldered on to a PCB. If dip soldered, cannot guarantee its reliability.

LED PCB

3.1.1 Soldering Iron

(1) When hand soldering, keep the temperature of iron below less 300 less than 3 seconds
 300 3

(2) The hand solder should be done only one time.

3.1.2 Repairing

Repair should not be done after the LEDs have been soldered. When repairing is unavoidable, a double-head soldering iron should be used (as below figure). It should be confirmed in advance whether the characteristics of LEDs will or will not be damaged by repairing.

LED

LED

3.1.3 Cleaning

The LEDs should not be cleaned with water, benzene, and/or thinner.

/ led

LED "C" "S"



4. Handling Precautions

4.1 Handling Precautions

4.1.1 Storage

(1) Moisture proof and anti-electrostatic package with moisture absorbent material is used, Suggest storage time is less than 6 months.

(2) Storage condition: temperature $\leq 30^{\circ}\text{C}$, humidity $\leq 60\% \text{ RH}$.

(3) Before opening the package, please check the package for air leaks, if there exists any air leaks, please return the product to our company for package after dehumidification by baking before your second use.

(4) After the package is opened, the product must be used in the specified environment of temperature below 30°C /humidity below $60\% \text{ RH}$, and soldered within 12HR. Unused material must be stored in the environment of temperature below 30°C /humidity below $10\% \text{ RH}$, These surplus products should be baked $65 \pm 5^{\circ}\text{C}/24\text{H}$ before next use.

12 :30 :10%RH
 :65±5 /24H

(5) Before SMT, LEDs need to be baked , baking requirement as below :



Customer pre-treatment conditions before use				
Condition before use	undamped Production date 2 months 2	undamped Production date 2-6 months 2-6	undamped Production date 6-12 months 6-12	damped or Production date exceed 12 months 12
Pre-treatment	Baked 65 ±5 /12H 65 ±5 /12H	Baked 65 ±5 /24H 65 ±5 /24H	Baked 65 ±5 /48H 65 ±5 /48H	Return to the original factory for processing

4.1.2 Static Electricity

Static electricity and surge voltage damage the LEDs. Damaged LEDs will show some unusual characteristics such as the forward voltage becomes lower, or the LEDs do not light at the low current and even not light. All devices, equipment and machinery must be properly grounded. At the same time, it is also recommended that anti-electrostatic wrist bands, pads, uniforms, gloves or containers can be used as effective measures when dealing with the LEDs.

4.1.3 Reverse voltage protection

In generally the reverse current of LED is very small, it can't effect using the component normally, but when it often suffered the reverse voltage which exceed the limits of the component than it will be damaged, the reverse current increases rapidly causing the string light display gray scale so when designing, please pay attention to control the reverse voltage we suggest the reverse voltage less than 5V.

LED ,
 ,LED ,
 , LED 5V.



4.1.4 The safe temperature for LEDs working

(1) If the junction temperature of LEDs is too high, the luminous intensity will decrease radically. When LEDs are working in a hot environment for a long time, they will be disabled easily. When LEDs are working in a hot environment, the junction temperature should be lower than 55°C and the case temperature should be lower than 75°C.

LED junction temperature, case temperature, ambient temperature, and heat sink temperature should be controlled within the specified range.

(2) Proper thermal management is an important when designing products with LEDs. LED die temperature is affected by PCB thermal resistance and LED spacing on the board. Please design products in a way that the LED die temperature does not exceed the maximum junction temperature (T_J).

(3) Drive current should be determined for the surrounding ambient temperature (T_A) to dissipate the heat from the product.

T_A

4.1.5 Directions for Use

(1) During designing a circuit, the current goes through each LED chip must not exceed the Absolute Max Rating current specified for each chip.

LED

(2) It is recommended that each LED chip is driven by a constant current.

LED

(3) When having the two or more dices within this product at the same time, the total power dissipation for the LED package must be within the max value specified in this specification.

LED

(4) This product should be operated with forward current. Make sure the product is not subjected to continuous reverse voltage because it may cause damage to the LED chip. If the display will not be



used for a long time, the main power should be switched off,Dehumidification is necessary before using the screen again.

LED

(5) Make sure that the reverse voltage will not exceed the Absolute MaxRatingwhen us9ETQq0.0000887



(8) In areas where hydrogen sulfide, which is a sulfide-based gas, is present (e.g. hot springs and volcanic areas), and where salt is abundant (e.g. coastal areas), the life may be shortened.

(9) When power g b d f c d g g c d c b g g * g f b c c b 100% wattage for the LEDs may have absorbed moisture. Before normal use of this display, operate the display at approximately 20% wattage for an initial time period.

LED 100
 20

(10) If the display units will be rented, those units should be selected carefully to ensure that the display as a whole will appear the same color and brightness.

(11) If the display modules are loaded onto and/or transported by ship, the moisture environment on the vessel can cause condensation; the display units should be packaged to prevent moisture absorption.

(12) If a display that has been, or is being, used is relocated, it is possible that degradation of the LED has occurred. When transporting this display, provide sufficient protection for the LEDs in addition to the moisture-proof packaging for the display. When this display is reinstalled, ensure to follow the installation instructions for environments and use.

LED
 LED

4.1.6 Others

(1) Do not directly touch or handle the epoxy surface. It may damage the internal circuitry. Handle the component along the side surfaces by using forceps or appropriate tools.



(2) Do not handle the LEDs with bare hands as it will contaminate the LED surface and may affect the optical characteristics: it might cause the LED to be deformed and/or the wire to break, which will cause the LED not to illuminate. The lead could also cause an injury.

LED

LED

LED

LED

(3) Do not stack assembled PCBs together. Otherwise, it may cause damage to the resin (e.g. cut, scratch, chip, crack, delamination and deformation) and the wire to break causing a catastrophic failure (i.e. the LED not to illuminate).

PCB

LED

(4) Other precautions, please refer to our "Ruifeng Photoelectric Full color SMD LED device User Manual".

SMD LED

4.1.7 Declare

(1) This specification is written both in English and in Chinese and the latter is formal.

(2) Both the customers and Refond will agree on official specifications of supplied products before

acceptance, Refond reserves the right to further modify the specification for technical reference and sample without noticing the customers.







www.refond.com



Declare

This specification is written both in English and in Chinese and the latter is formal.

